

## Installation:

The L10 Vandal Proof LED Exit can be installed either Ceiling or Wall Mounted. When wall mounted, it can be flat/back to the wall or as a Flag extending from the wall.

### All versions (Assembly preparation)

- Remove the 4 security screws which hold the assembly together.
- Remove the bottom cover frame whilst holding the side covers.
- Disengage the Cleverfit Pro from the slide connect bracket.
- Remove the terminal block cover.
- Remove the slide bracket from the top mounting frame.

### Ceiling Mount

- Using the Top frame as a guide, mark 4 holes for mounting and one for mains access.
- Install the top frame to the ceiling using appropriate fixings (not supplied).
- Route the power cable through the access hole.
- Install the Cleverfit Pro slide bracket with the power cable through the access hole.
- Connect the power to the terminal block.
- Reinstall the terminal block cover.
- Reinstall the Cleverfit Pro Exit to the slide bracket.

### Wall Mount

- Using the solid Polycarbonate sheet as a guide, mark 4 holes for mounting and one for mains access.
- Install the solid Polycarbonate sheet to the wall using appropriate fixings (not supplied).
- Route the power cable through the access hole in the Polycarbonate.
- Position the top frame over the Polycarbonate sheet.
- Install the Cleverfit Pro slide bracket with the power cable through the cable entry.
- Connect the power to the terminal block.
- Reinstall the terminal block cover.
- Reinstall the Cleverfit Pro Exit to the slide bracket.

### All versions (Final Assembly)

- Ensure the 2 clear slide covers are inserted back into the bottom frame
- Re-install the bottom frame to the top frame, whilst aligning the side covers into the top frame, using the 4 security screws which hold the assembly together.

## Testing and Maintenance

Refer to the Cleverfit Pro Installation Instruction sheet provided with the fitting for all test and maintenance procedures.

Note that in order to scan the LED on the fitting for Clevertest Plus , the bottom part of the vandal proof housing needs to be removed.

## Rated Emergency Lumen Output in accordance with AS2293.1 (refer to spacing tables for installation positions): (N/A for -SP fittings)

Refer to the Technical Label for classification information.



# L10™ LED Vandal Proof Exit Installation & Maintenance Instruction Leaflet



### Victoria (Head Office & Manufacturing)

Website: [www.clevertronics.com.au](http://www.clevertronics.com.au)

Email: [info@clevertronics.com.au](mailto:info@clevertronics.com.au)

Phone: +61 3 9559 2700

Fax: +61 3 9559 2799

### New South Wales

Phone: +61 2 8805 6400

Fax: +61 2 8805 6444

### Queensland

Phone: +61 7 3442 9700

Fax: +61 7 3442 9777

### South Australia/Northern Territory

Phone: +61 8 8301 8800

Fax: +61 8 8351 8286

### Western Australia

Phone: +61 8 9207 0000

Fax: +61 8 9207 0088

### New Zealand

Phone: +64 800 548 448

Designed in Australia to comply with the requirements of AS2293.3: 2005 and AS/NZS CISPR15: 2017.

NOTE: Standard product codes with this symbol  are enabled with Clevertest Plus capability. Please refer to the operation guide supplied with the product for details.

## Models:

LVELED-yy-xx-vv

### Testing:

Manual Test xx = Blank

Zoneworks  $\bar{x}\bar{x}$  = ZW

Z/W DATA xx = DATA

Zoneworks HIVE xx = HV

DALI Registered. xx = DALI

Clevertest xx = CT



### Options:

Wall Mount

Ceiling Mount

Flag Mount

Special Sign

yy = WM

yy = CM

yy = FM

vv=SP

(NOTE: -CT Products supplied with the Clevertest Plus Symbol  are activated with Clevertest PLUS capability. Please refer to the operation guide supplied with the product for details).

## Important:

It is illegal for anyone, except for a licensed electrician to install or maintain this product. Before installation, ensure that the electricity supply has been switched off and isolated. Installation must be carried out in accordance with the relevant Australian and International Standards.

# INSTALLATION IMAGES

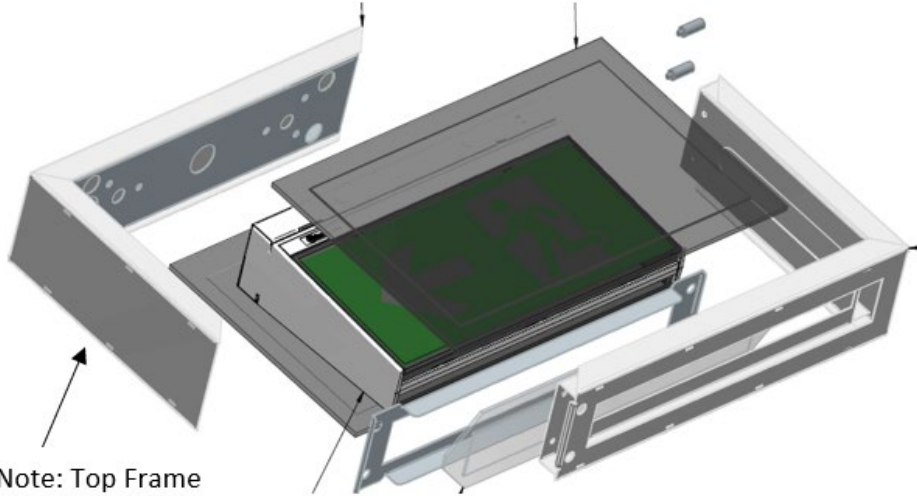

Note: Top Frame  
(for all versions)

**CEILING MOUNT METALS and ASSEMBLY**

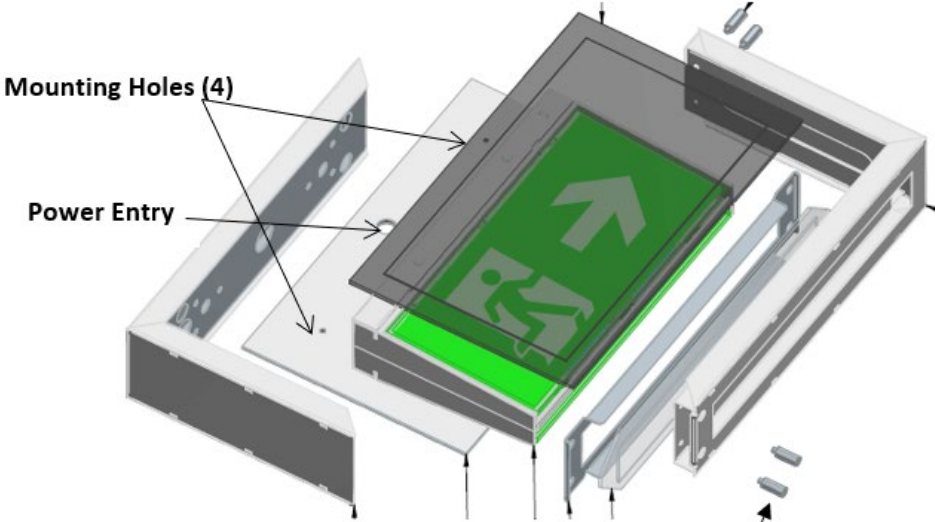

Mounting Holes (4)

Power Entry

**WALL MOUNT METALS and ASSEMBLY**

Note: Security Screws x 4  
(for all versions)

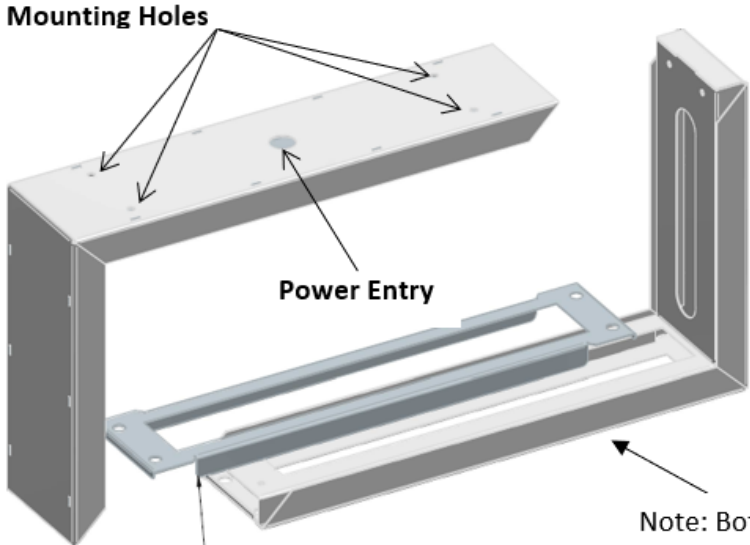

Mounting Holes

Power Entry

Note: Bottom Frame  
(for all versions)

**CEILING MOUNT METALS**

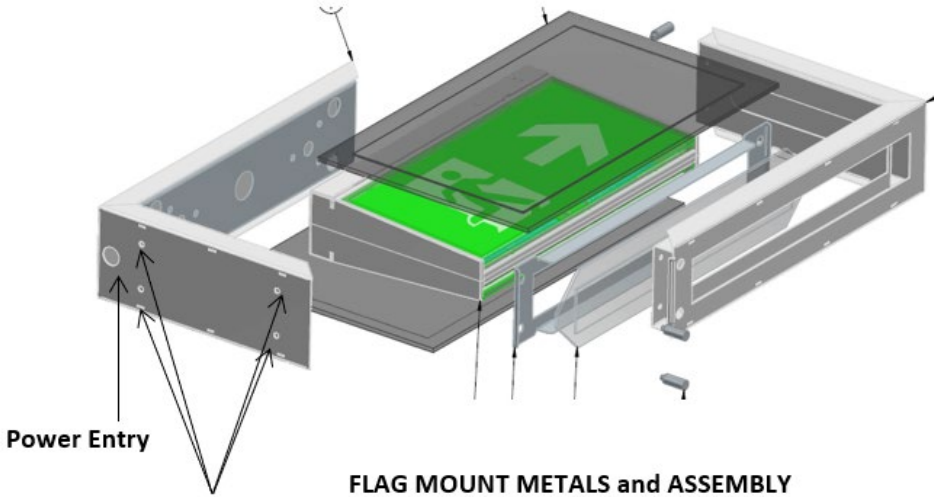

Power Entry

Mounting Holes

**FLAG MOUNT METALS and ASSEMBLY**